

HN-P-6M Series Lens

HN-P-1628-6M-C1/1.8



- F=16mm
- 2.4 μ m
- F2.8
- for 1/1.8 type Cameras, 6 Megapixel
- Ultra-low optical distortion
- Miniaturized structure

Specifications

Model	HN-P-1628-6M-C1/1.8
Sensor Size	1/1.8"
Pixel size (μ m)	2.4
Focal Length (mm)	16 \pm 5%
Total Track Length (mm)	45 \pm 0.2
Flange distance (mm)	17.526 \pm 0.2
F/No.	F2.8-F16
Angle of View (D \times H \times V)	32.53 $^{\circ}$ \times 25.81 $^{\circ}$ \times 17.53 $^{\circ}$
Optical Distortion(%)	\pm 0.1
Basic Working Distance (mm)	300
Focus Range	0.1m- ∞
Filter Thread (mm)	M27 \times 0.5
Mount	C-mount
Dimensions (mm)	Φ 33.0 \times 31.9 (w/o thread)
Weight	56g

Technical Drawing

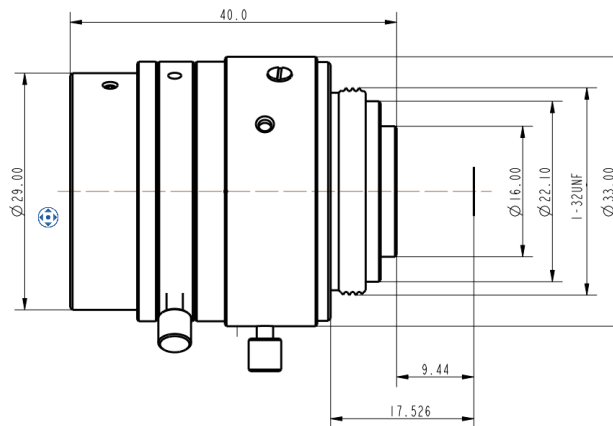

China Daheng Group, Inc. Beijing Image Vision Technology Branch

12F Daheng Science & Technology Tower, No.3 Suzhou Street, Haidian District, Beijing China, 100080

Tel: +86 10 82828878

E-mail: isales@daheng-imaging.com